

Installation should only be completed by individuals skilled with the necessary tools for installation. If you doubt your skills, please consult a qualified installer.

Tools Needed:

- Caulking Gun
- Drill
- Drywall Saw
- Flashlight
- Flat Bar
- Hammer
- Marking Pencil
- Measuring Tape
- Reciprocating Saw
- Safety Goggles
- Screwdriver
- Stud Finder
- String
- Tin Snips
- Utility Knife
- Wire

Important Precautions:

- Light pipe material is very sharp when cut. Please use extreme caution when handling the light pipe.
- Light pipe is very bright, use proper eye protection when installing. **AVOID LEAVING THE PIPE EXPOSED TO THE SUN WITHOUT THE PROTECTIVE COATING OR DIFFUSERS IN PLACE PRIOR TO INSTALLATION.** (The protective coating should only be removed during Step 14.)
- Ensure normal safety precautions are taken when using tools and walking on roofs.
- Do not cut any structural members in the house.
- Ensure wire runs, plumbing or ventilation ducts will not interfere with the light pipe installation.
- Measure twice and cut once.

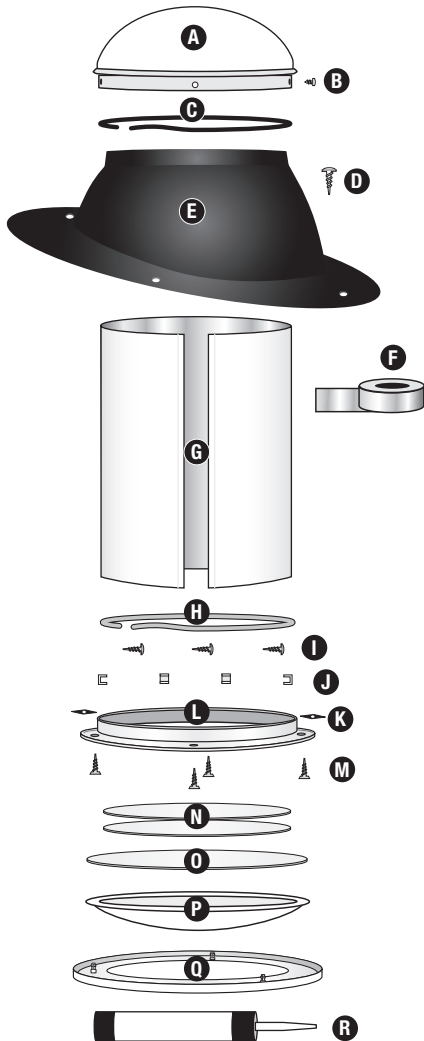

Components and Hardware Parts List:

- A. Clear acrylic dome
- B. (4) Phillips head stainless steel 1/4" sheet metal screws
- C. Black nylon horse hair gasket (self-adhesive backed)
- D. (6) Phillips head stainless steel 1 1/2" screws
- E. Heavy-duty aluminum flashing
- F. Foil tape
- G. (2) 24" reflective light pipes
- H. White nylon horse hair gasket (self-adhesive backed)
- I. (8) Tek screws
- J. (4) U-channel PVC self-adhesive tabs
- K. (3) Black speed nuts
- L. Aluminum ceiling ring
- M. (3) 1 1/2" Phillips flathead screws
- N. (2) Small Clear Polycarbonate Lenses
- O. (1) Large Clear Polycarbonate Lens
- P. Prismatic diffuser
- Q. White light fixture/trim ring
- R. Caulk

Helpful Hints...

- When determining location of the unit, southern exposure is recommended. Also consider potential problems such as objects shading the unit during certain times of the day.
- Although adjustable elbows are available for use, straight light pipe runs result in higher light output and easier installation.
- Prior to starting the job, cut packaging straps on the light pipe and uncoil the tubes.
- It is highly critical to check for obstructions above the ceiling which may hinder the installation. If possible, visually check to ensure that there are no electrical wires or other obstructions where you plan to install the SolarSkyLite. If you can not check visually, use a piece of wire as outlined in Step 1.

Installation...

Please allow 2 hours for installation. Components and hardware are referenced in each step to the corresponding letters on parts list (on front page).

STEP 1 To facilitate installation, once the desired location is obtained, ensure that there are no obstructions in the attic between the roof and ceiling or on the roof. With a stud finder, locate the ceiling joists and center the ceiling ring (L) between joists as close to the desired installation area as possible. Mark the center of the ceiling ring (L), drill a hole and insert piece of wire bent at a 90 degree angle. Rotate the wire around 360 degrees. While rotating, feel for resistance that could indicate wire runs or other obstructions.

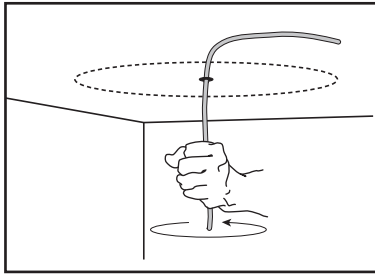

Mark the center of the ceiling ring (L), drill a hole and insert piece of wire bent at a 90 degree angle. Rotate the wire around 360 degrees. While rotating, feel for resistance that could indicate wire runs or other obstructions.

STEP 2 If there are no obstructions, scribe mark around the ceiling ring inner ring (L). Using a drywall saw, cut out the scribed mark in the ceiling.

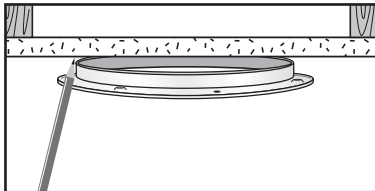

STEP 3 Install the ceiling ring (L) on the ceiling. Place ceiling ring in the hole cut in Step 2. Peel the protective covering off the white horse hair gasket (H) and apply gasket to the inner lip of the ceiling ring (L). This gasket ensures a dust free fit between the light pipe and the ceiling ring. Secure the ceiling ring to ceiling by inserting a 1 1/2" Phillips flathead screw (M) into one of the three pre-drilled dimpled holes and screwing it up through the drywall into speed nut (K) provided. Repeat this process for the other two screws.

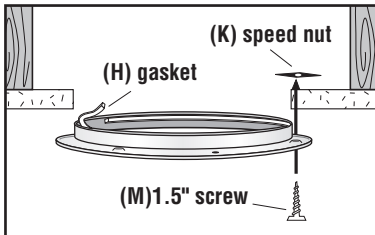

STEP 4 Place a ladder under ceiling ring hole and place a flashlight on top of ladder. The resulting flashlight beam will mark the location for centering hole. With a drill bit and appropriate extension rods, drill a pilot hole in the marked location on bottom side of roof. If attic is accessible, a plumb-bob may also be used.

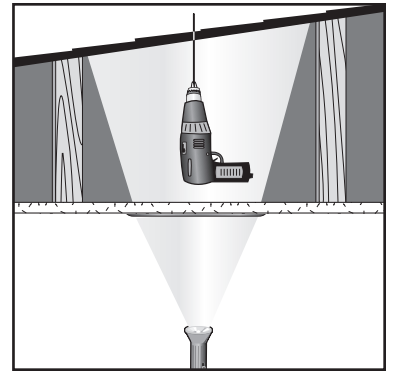

STEP 5 On the roof, locate the centering hole and outline the diameter of the hole that the pipe will pass through by turning the flashing (E) upside down and marking the inside of the flashing unit.

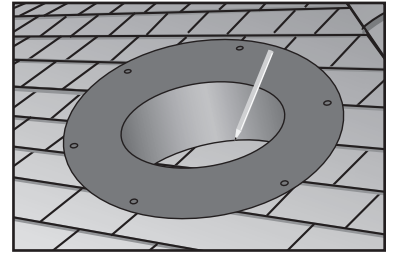

STEP 6

IMPORTANT: Light pipe must pass between roof rafters. **DO NOT CUT THROUGH ANY FRAMING MEMBER.** With a reciprocating saw, cut the diameter of the hole 2" larger than the area marked in Step 5.

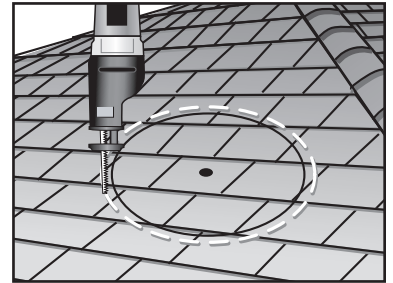

STEP 7 With a utility knife, cut a four inch slit through the shingles and tar paper at the 3:00 and 9:00 o'clock positions of the flashing. This allows for the footprint of the flashing to be inserted under the shingles.

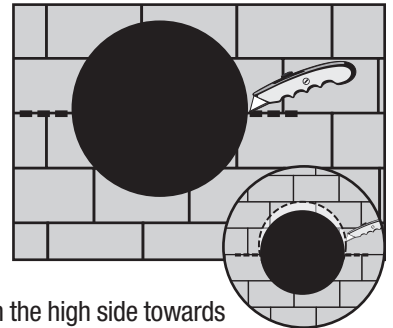

NOTE: Additional shingles may also need to be removed on the high side towards the ridge to allow the flashing to slide over hole (see inset).

STEP 8 Insert the reciprocating saw blade sideways at the 3:00 o'clock position and start cutting the roofing nails up and around to the 9:00 o'clock position. This process removes the nails that will prevent the flashing footprint from sliding up underneath the shingles.

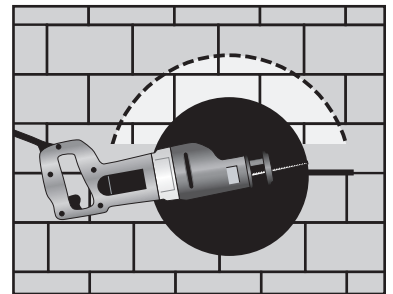

STEP 9 Caulk the underside of the flashing (E) with the provided caulking material (R). Two concentric rings of caulking material is sufficient.

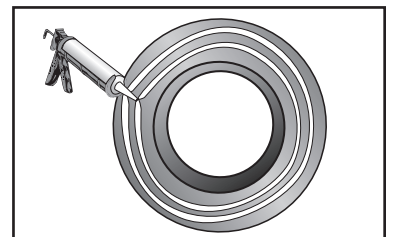

STEP 10 Taking care not to smear caulk on the exposed shingles, slide flashing under tar paper and shingles and force flashing up until the shingles come in contact with the raised portion of the flashing. The bottom side of the flashing will be on top of the shingles. Secure flashing with (6) Phillips head screws (D).

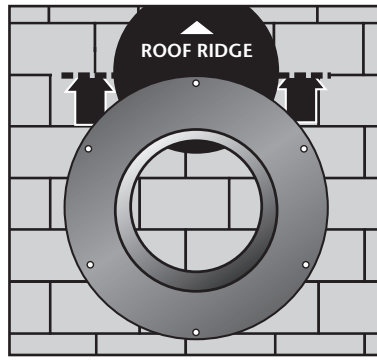

STEP 11 Apply caulk over all exposed screw heads (since they will be exposed to the weather). Use remaining caulk to seal the areas where the 4" slits were made and around area where shingles meet with raised area of the flashing.

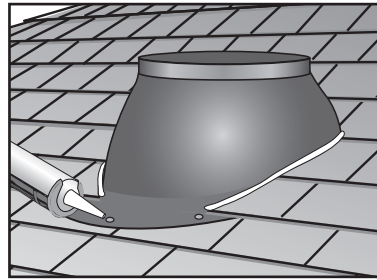

STEP 12 Peel the protective backing off the black horse hair gasket (C) and apply gasket on the inner lip of the flashing collar (E).

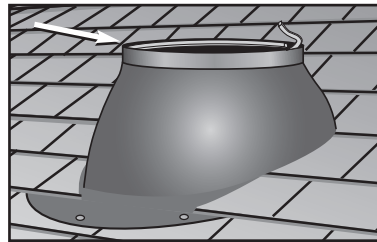

STEP 13 To assemble light pipe (G), peel back the protective coating that covers the mirror coating about 1" from the opposite edge of the double-sided tape. Remove the paper cover over double-sided tape and overlap 3/4" to the scribe line. Put pressure on both sides of seal to ensure a good bond. Secure the tube using the provided tek screws (I) - two screws per tube. Then place foil tape (F) over the entire seam to strengthen seal.

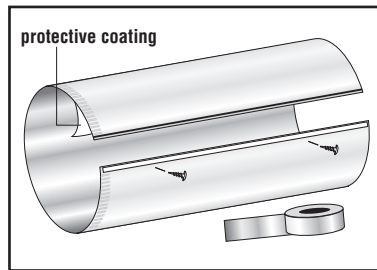

STEP 14 When joining the two light pipe sections (G) together, with the crimped end down, place crimped end of one pipe into the non-crimped section of the other pipe. Secure with two tek screws (I) and seal joints with foil tape (F).



IMPORTANT: Remove protective coating that covers the mirror finish inside the tube.

STEP 15 Insert light pipe (G) through the flashing unit with crimped end down (E) and gently rock pipe back and forth with slight downward pressure until pipe terminates evenly with the inner collar of the ceiling ring (L). Trim any excess light pipe with tin snips. Secure bottom of light pipe to ceiling ring with two tek screws (I). **NOTE:** Use caution, light pipe is extremely sharp.

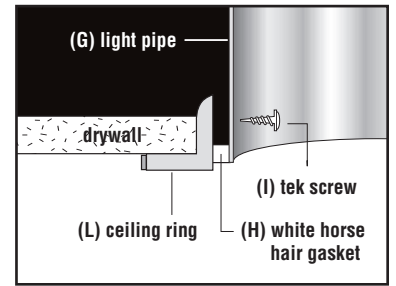

STEP 16 If there is excess light pipe (G) sticking out of the flashing, using tin snips, cut from the top down to the lip of the flashing and trim off the excess pipe. **NOTE:** Use caution, light pipe is extremely sharp.

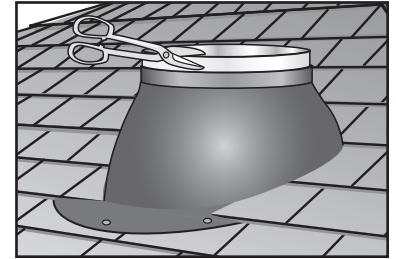

STEP 17 Place dome (A) on top of the flashing unit (E). Secure the dome to the flashing by screwing (4) 1/4" sheet metal screws (B) through the pre-drilled holes on the dome collar and into the lip of the flashing.

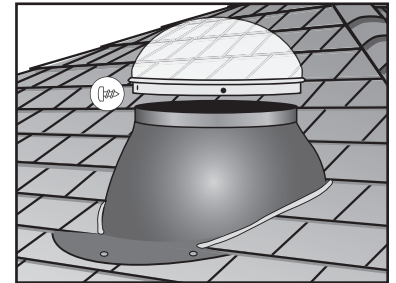

STEP 18 Remove paper backing from the adhesive tape on the U-channels (J) and place 1.5" from bottom of light pipe equidistant from each other so legs of the U-channels align vertically.

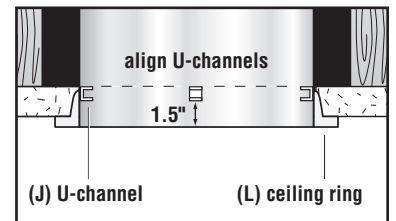

STEP 19 Remove protective film from both sides of small lenses (N). Place one lens on TOP of the U-channel leg (J) and the other lens (N) on the BOTTOM of U-channel leg (J) (see close-up).

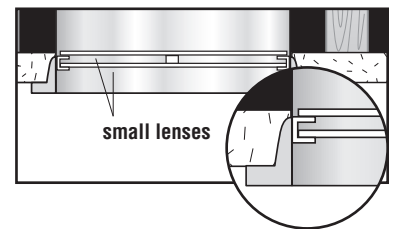

STEP 20 Place the diffuser (P) into the white powder coated trim ring (Q). Remove protective film from both sides of large lens (O) and place on top of diffuser (P).

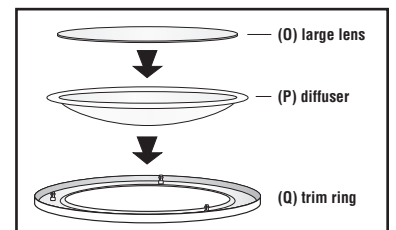

STEP 21 Line up the three steel pins of the white trim ring (Q) with the holes on the ceiling ring (L). Push up to snap in place.

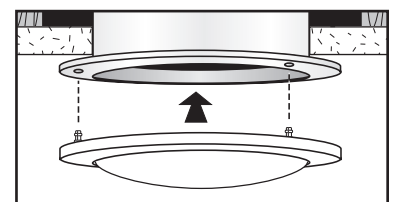

– Please fill out the date your purchased the Greenergy Tubular Skylight on the warranty certificate below and save for your records –

GREENERGY WARRANTY

**The Greenergy Tubular Skylight has a 25 year warranty
against manufacturers defects and deterioration.**

IMPORTANT: Please complete and mail the registration card below as soon as your Greenergy Tubular Skylight is installed. This warranty will serve as proof of your purchase, should you misplace your original invoice.

The manufacturer warrants this product and its components to be free from defects in material and manufacturer's workmanship for a period of twenty five years from the date of installation. This warranty is subject to proper installation of the unit in accordance with the manufacturer's written installation instructions. The manufacturer will not be liable for any special, incidental or consequential damages in any way related to, or arising out of, defects in, or damage to, the Greenergy Tubular Skylight.

This warranty gives you specific legal rights, and you may have other rights which vary from state to state concerning exclusion or limitation of incidental or consequential damages.

Date purchased: _____



*Please contact your Greenergy dealer
or installer if you have any questions
or to purchase additional accessories.*

REGISTRATION CARD

Customer name: _____

*Please fill out the
registration card
and mail to:*

Where unit was purchased: _____ Date purchased: _____

Street address: _____

City: _____ State: _____ Zip: _____

Phone: _____ Email: _____

**Greenergy Tubular
Skylight Registration
P.O. Box 71043
Phoenix, AZ 85050**

Are you satisfied with the performance of the Greenergy Tubular Skylight? Yes No

Are you interested in other eco-friendly home products? Yes No

To help us improve our products, please include any comments:

